

Agilent 71400 Lightwave Signal Analyzer

Application Note 371

Measuring Modulated Light

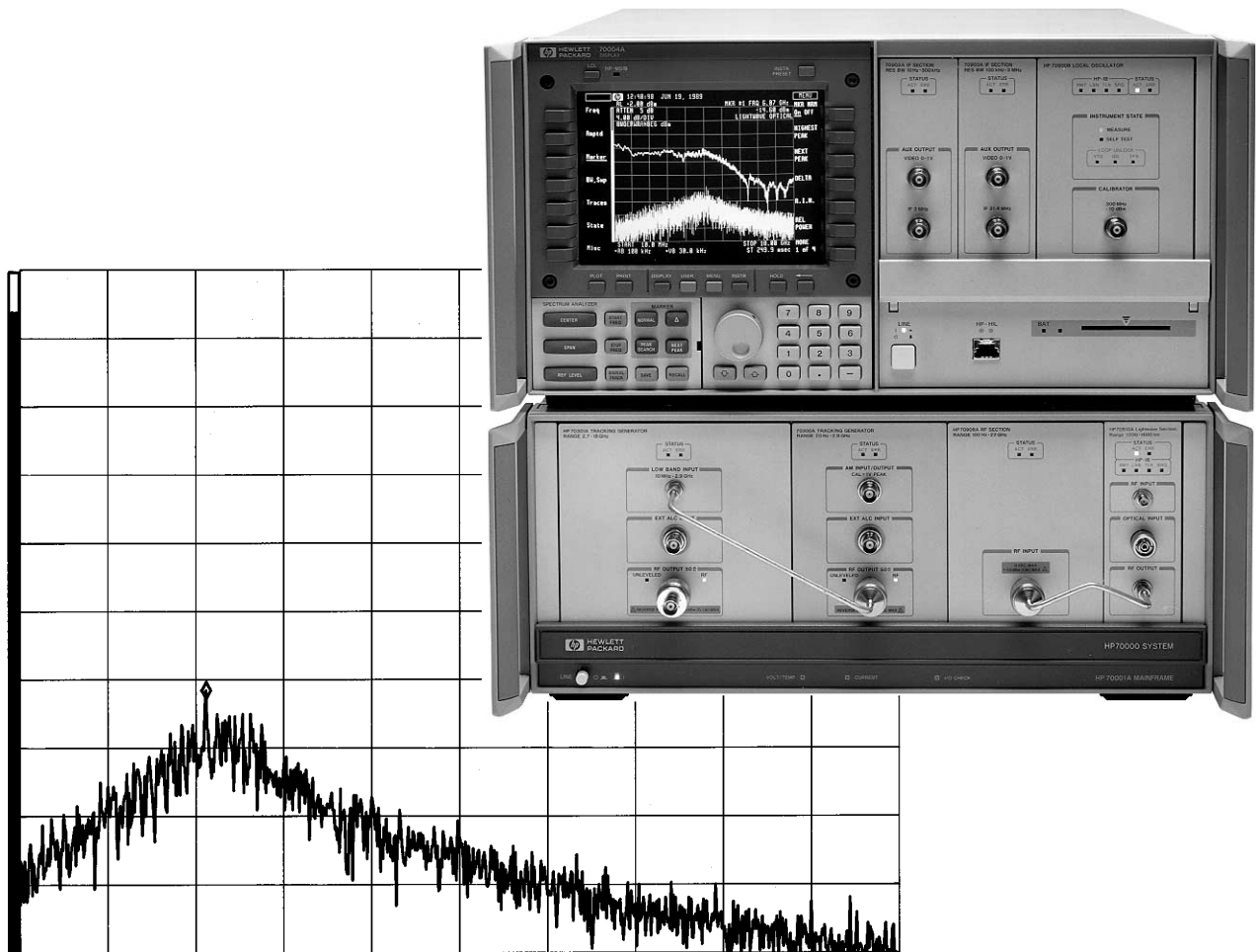

Table of Contents

	Page
Introduction	3
Chapter I. Generating, Detecting, and Displaying Modulated Light	4
Generating Modulated Light	4
Intensity Modulation Detection and Display	6
Intensity Noise Measurements	8
Relative Intensity Noise	11
Frequency Modulated Light	12
References	16
Chapter II. Using the Lightwave Signal Analyzer	17
System Description	17
Operation	18
Electrical Calibration	18
Connector Cleaning	18
Main Menu	19
User-Defined Menu	19
Operating Modes	20
Lightwave Modes	20
Bypass the Lightwave Input	21
Measurement Example	21
Chapter III. Agilent 71400C Measurement Examples	24
Modulated Laser Power	25
Detected Electrical Power	26
Low-level Signals	27
Relative Intensity Noise (RIN Lasr)	28
Relative Intensity Noise (RIN SYS)	30
Cable Reflections and Noise	31
Modulation Linearity of Laser Diode	32
Pulsed Laser Modulation Spectrum	33
PRBS Digital Modulation Spectrum	34
Frequency Response and Intensity Noise	35
Frequency Response with Tracking Generator	36
Linewidth of DFB Laser Diode	38
Chirp of a Modulated DFB Laser	40
FM Power Spectrum of a DFB Laser	41
Optical Heterodyne YAG Laser Spectrum	42
Photoreceiver Frequency Response	43

Introduction

Modern fiber-optic communication systems need to modulate information onto infrared light. This allows propagation through optical fibers with the greatest possible fidelity. The quest for faster information transfer rates and greater propagation distances, as well as the development of microwave-frequency analog-modulated systems, has driven development toward the use of single-mode fibers. These fibers propagate light at wavelengths of 1300 and 1550 nanometers.* The sources and detectors of modulated light are key components in such systems.

The Agilent 71400C and Agilent 71401C lightwave signal analyzers have been designed to help developers and users of these key components measure important characteristics such as signal strength, modulation bandwidth, signal distortion, noise, and the effects of reflected light. Used in conjunction with the Agilent 11980A fiber-optic interferometer, these lightwave signal analyzers can also measure linewidth, chirp, and frequency modulation of single-frequency lasers. All are important properties for high-performance systems.

This application note explains how the Agilent 71400C lightwave signal analyzer is used to perform measurements related to modulated light. Chapter I discusses the generation and detection of modulated light. Chapter II explains use of the lightwave signal analyzer. Chapter III presents practical measurement examples.

* For a definition of terms related to fiber-optic communications, see “Fiber Optics Handbook” 2nd edition (1988) by C. Hentschell. This reference is available from Agilent. Order document number 5952-9654.

Chapter I

Generating, Detecting, and Displaying Modulated Light

Generating Intensity-Modulated Light

Lightwave communication sources such as light-emitting diodes (LEDs) and multi-mode or single-mode laser diodes (LDs) produce light at similar wavelengths. However, these sources produce very different spectral distributions, as shown in figure 1. The light-emitting diode distributes its energy over a wide spectral range and is not a coherent source. The Fabry-Perot laser diode emits coherently, but at many frequencies simultaneously. Single-mode lasers with narrow spectral linewidths, such as the distributed feedback (DFB) laser, have only one frequency output but can suffer linewidth broadening when modulated.

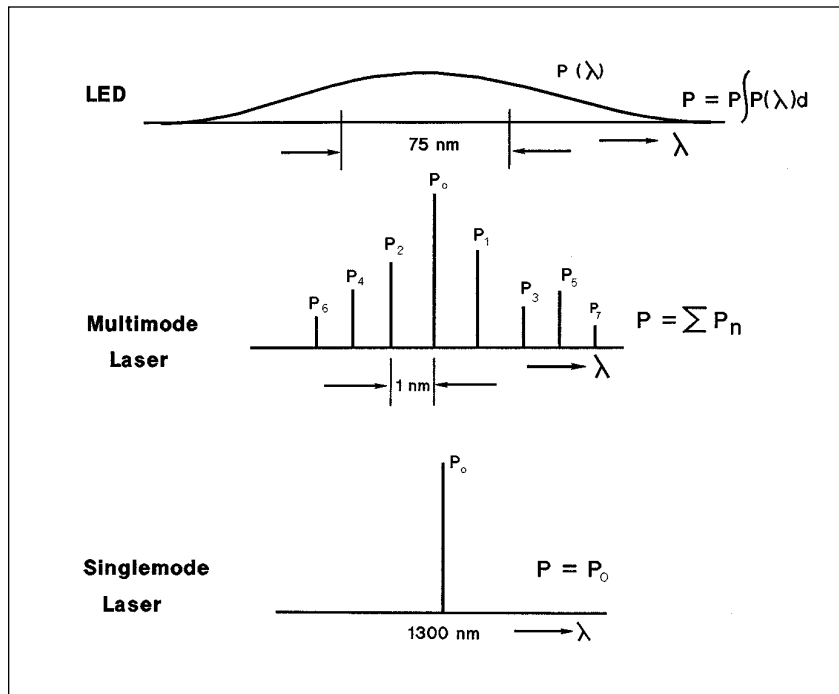

Figure 1. Spectra of typical lightwave communication sources

Most lightwave communication systems transmit information by modulating the total optical power. This technique is known as intensity modulation, and its generation is described in figure 2.

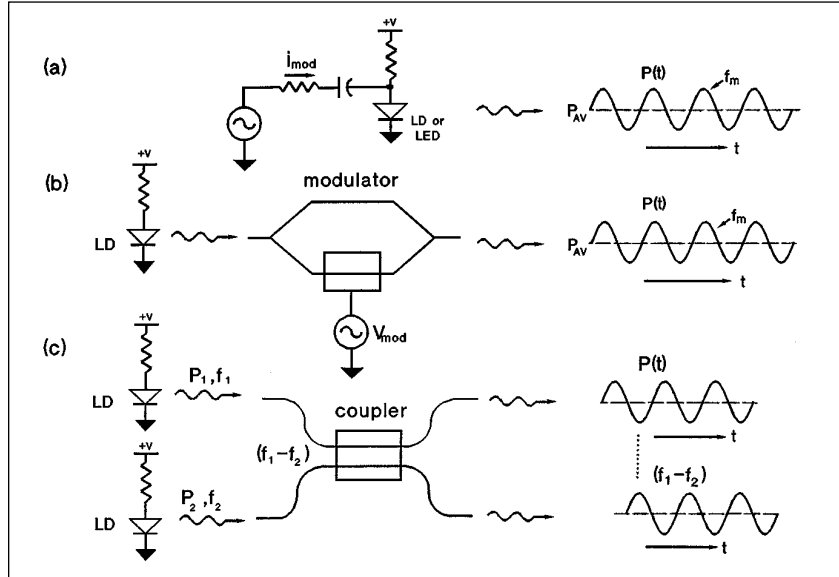

Figure 2. Methods of generating intensity-modulated light

(a) direct modulation of a laser or LED

(b) electro-optic modulation

(c) heterodyne interferometry

For the case of direct sinusoidal modulation, as seen in figure 2(a), the time-varying optical power can be expressed as:

$$P(t) = P_{AVG} + P_{MOD} \cos(2\pi f_m t) \quad (1)$$

Where; P_{AVG} = Average optical power
 P_{MOD} = Modulated optical power
 f_m = Modulation frequency

Figure 2 shows two additional methods of generating intensity-modulated light. Electro-optic modulation, in which transmission attenuation can be controlled with applied voltage, is used to modulate light from unmodulated lasers and is shown in figure 2(b). Another method, optical heterodyne interferometry, combines light from two narrow-linewidth, single-mode lasers in an optical coupler or beam splitter and is shown in figure 2(c). The light emerging from both output arms of this coupler, when detected, exhibits an intensity fluctuation, or modulation, at a rate equal to the frequency difference between the two input lasers. For a 100 percent beam-combining efficiency in the heterodyne modulation scheme of figure 2(c), the magnitude of the modulated optical power equals the sum of the average power and the modulated power:

$$P(t) = 1/2 * (P_{1AVG} + P_{2AVG}) + (P_{1AVG} * P_{2AVG})^{1/2} * \cos[2\pi(f_2 - f_1)t] \quad (2)$$

If you know the average power of each laser, this method provides a known amount of modulated optical power at the difference frequency, $f_2 - f_1$. By carefully controlling the magnitudes of P_{1AVG} and P_{2AVG} , and the beam combining efficiency, you can use this means of modulating optical power as a reference standard for calibrating optical systems¹ (as is done in the Agilent 71400C system).

Intensity Modulation Detection and Display

Figure 3 illustrates the processes of generation, detection, amplification, and display of intensity-modulated light. The laser diode generates an optical average power proportional to its average bias current above the lasing threshold. It also generates modulated optical power proportional to the amplitude of the modulating current. The Agilent 71400C lightwave signal analyzer displays average optical power (P_{AVG}) as a solid bar at the left edge of the screen and modulated power (P_{MOD}) as a line at f_{MOD} which has a height proportional to the modulated power.

Both displays at the bottom of figure 3 are of the frequency domain. They contain information about the modulation spectra but not about wavelength, and they are quite different from the displays in figure 1. In figure 1, optical power versus wavelength is displayed, but modulation information is not shown. This illustrates the fundamental difference between a lightwave signal analyzer and an optical spectrum analyzer. The lightwave signal analyzer displays the total average power and the modulation, or baseband spectrum; an optical spectrum analyzer shows the spectral, or wavelength, distribution of the average optical power.

In figure 3, the modulated optical power is converted to current in a photodetector and then amplified to produce an output voltage, $V(t)$, across a load resistor, R_L . The relationship between the modulated optical-input power and the output voltage is:

$$V(t) = r_v * P_{opt}(t) = \underbrace{r_v * P_{AVG}(opt)} + \underbrace{r_v * P_{MOD}(opt) \cos(2\pi f_m t)} \quad (3)$$

In the right side of the equation, the **first term** is the detected voltage due to the average power, the **second term** is the detected voltage due to the modulated power, and r_v equals the voltage responsivity (volts/watt) of the detector and preamplifier.

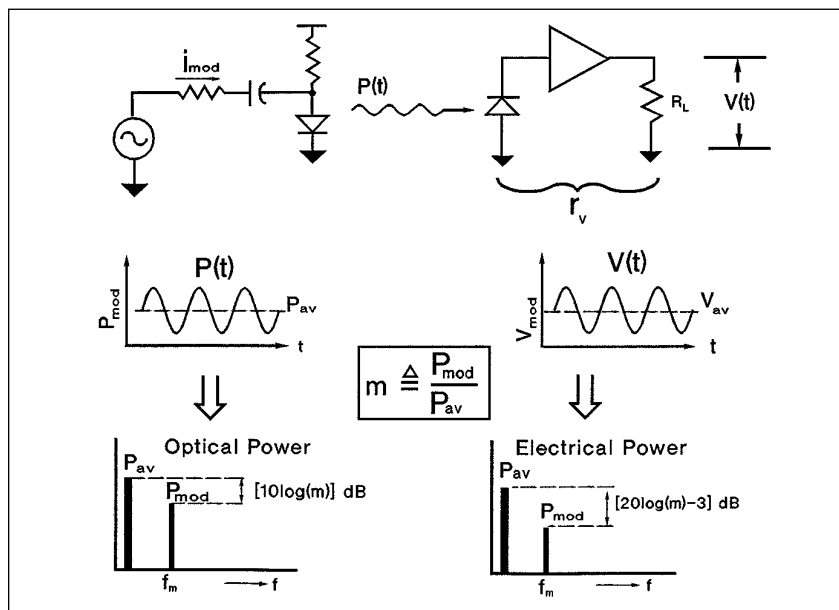

Figure 3. Generation, detection, and display of intensity-modulated light in both optical and electrical parameters

The lightwave signal analyzer can also display the electrical power resulting from the detected voltage, as figure 3 shows. The analyzer displays the average electrical power generated by the laser's output as a solid bar at the left side of the display. The analyzer also displays the modulated electrical power that is generated by the root-mean-square (rms) voltage detected by the photodiode.

Because the detected output voltage of the photodetector is a linear replica of the optical power, the ratio of modulated power to average power differs for the optical and electrical cases. To distinguish between the measurement in dB of optical power and the measurement in dB of electrical power resulting from square-law detection process, the terms "optical dB" and "electrical dB" are often used.

Also, the displayed electrical modulated power is based on the rms of the detected voltage, whereas modulated optical power is displayed equal to the peak amplitude of the peak of the individual Fourier components of the modulated optical waveform. Equations 4 and 5 summarize the relationship between displayed optical power and displayed electrical power.

$$P_{\text{AVG}}(\text{elec}) = \frac{[r_v * P_{\text{AVG}}(\text{opt})]^2}{R_L} \quad (\text{for average power}) \quad (4)$$

$$P_{\text{MOD}}(\text{elec}) = \frac{1/2[r_v * P_{\text{MOD}}(\text{opt})]^2}{R_L} \quad (\text{for modulated power}) \quad (5)$$

Notice that the relative power, the ratio of modulated power to average power, is different for the electrical case versus the optical case:

$$\text{RELATIVE POWER}(\text{opt}) = P_{\text{MOD}}(\text{opt}) / P_{\text{AVG}}(\text{opt}) \quad (6)$$

$$\text{RELATIVE POWER}(\text{elec}) = 1/2 [P_{\text{MOD}}(\text{opt}) / P_{\text{AVG}}(\text{opt})]^2 \quad (7)$$

Therefore, the displays of optical power and electrical power differ in the way each displays $\text{RELATIVE POWER} = P_{\text{MOD}} / P_{\text{AVG}}$. That difference is summarized in table 1, where **m** represents the optical relative power.

	Average Value	Modulated Value
Optical Power	$P_{\text{AV}}(\text{opt})$	$P_{\text{MOD}}(\text{opt})$
Detected Voltage	$r_v * P_{\text{AV}}(\text{opt})$	$r_v * P_{\text{MOD}}(\text{opt})$
Electrical Power	$\frac{[r_v * P_{\text{AV}}(\text{opt})]^2}{R_L}$	$\frac{[\sqrt{1/2} * r_v * P_{\text{MOD}}(\text{opt})]^2}{R_L}$

Table 1. Displayed optical power and displayed electrical power relationship

The electrical relative power, shown in figure 3, is twice the optical dB and is offset 3-dB downward, compared to the optical relative power. The 3 dB must be subtracted because the modulated power is expressed in peak-amplitude terms in the optical display, while the electrical display provides modulated power based on the rms voltage. When the average power and the modulated power are both displayed in electrical units, a 100-percent sinusoidally modulated optical signal ($m=1$) will yield modulated power 3-dB lower than the average power. The Agilent 71400C takes this distinction into account for each measurement.

Intensity Noise Measurements

The shape and amplitude of a laser's intensity-noise spectrum provides very useful information about the laser. Spurious, random emissions cause intensity fluctuations in the laser's light output. These fluctuations form the noise floor, which varies with frequency and peaks at the relaxation resonance of the laser. The location of the relaxation resonance, or intensity-noise peak, is related to the maximum modulation rate of a given laser. This resonance appears as a peaking in the frequency response, as shown in figure 5, or as a rise in the noise floor of the unmodulated laser, as shown in figure 4. Interaction between the optical field in the laser and the injected-electron density due to the bias current causes the peaking in both responses. Oscillations of both the output light and the electron density result.²

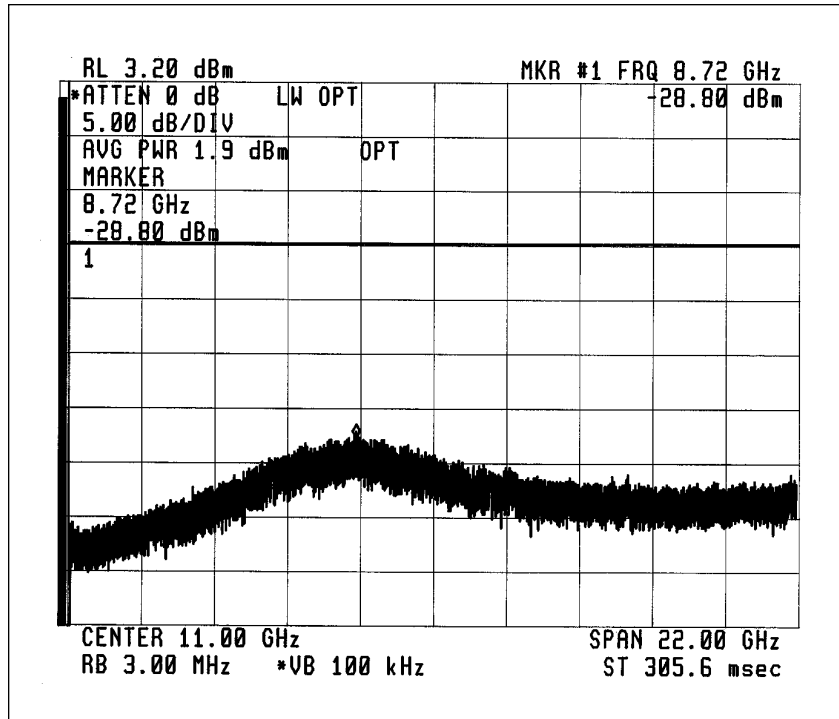

Figure 4. Relaxation resonance appears as a peaking in the intensity noise floor of an unmodulated laser.

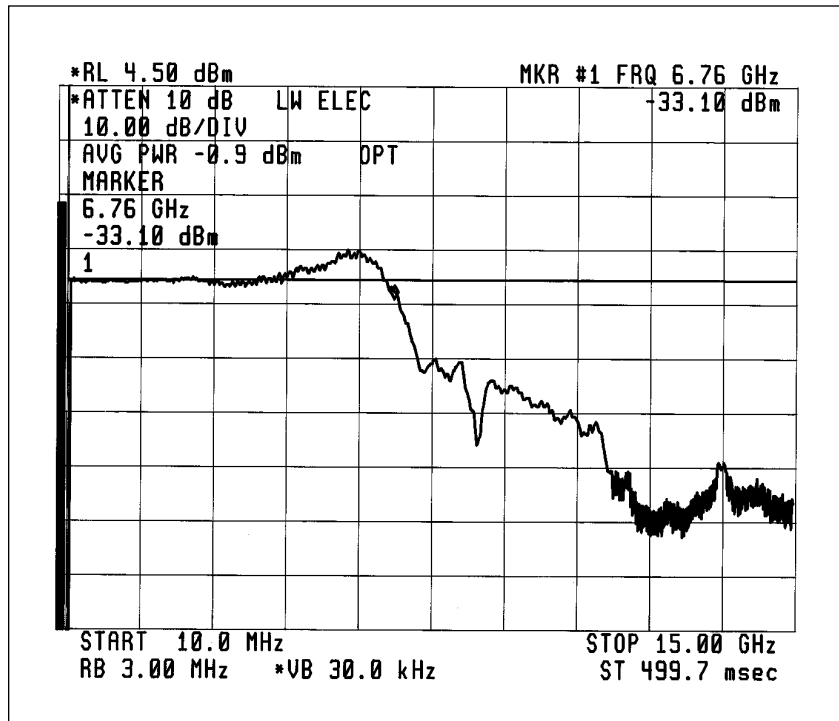

Figure 5. Frequency response of a diode laser. The characteristic response of the laser limits the frequency response.

The position of the relaxation resonance is most readily affected by the current bias level. Thus, monitoring the noise peak and adjusting the bias can provide valuable information regarding the operation and frequency response of the laser.

Displaying both the frequency response and the intensity noise floor, as in figure 6, allows two important properties of high-speed lasers to be monitored simultaneously: modulation response and intensity noise as a function of frequency. Due to a decrease in the signal-to-noise ratio, operation near the relaxation frequency should be avoided for satisfactory system performance.

The noise floor of the test instrumentation often is a limiting factor in performing noise measurements. Nowhere are the requirements of sensitivity more important than in measuring laser intensity noise and relative intensity noise (RIN). The Agilent 71400C addresses this in two ways. First, the Agilent 71400C utilizes an electrical spectrum analyzer (the Agilent 71210C). This analyzer has a fundamentally mixed front end, which results in a flat, low noise floor to 22 GHz. Second, the Agilent 70810B lightwave module includes a preamplifier. It provides a 32-dB gain with an 8-dB noise figure, resulting in excellent sensitivity over the 100-kHz to 22-GHz range.³

Equivalent electrical noise-floor sensitivities of -165 dBm/Hz result from the low, flat noise floor of the electrical spectrum analyzer and the built-in preamplifier. Translating this electrical system noise floor to optical sensitivity (taking into account the responsivity of the photodiode in a 50-ohm system) typically provides a -73 dBm/Hz optical noise floor. Thus, the Agilent 71400C allows quick measurements of the intensity noise spectrum of the laser in either electrical or optical terms.

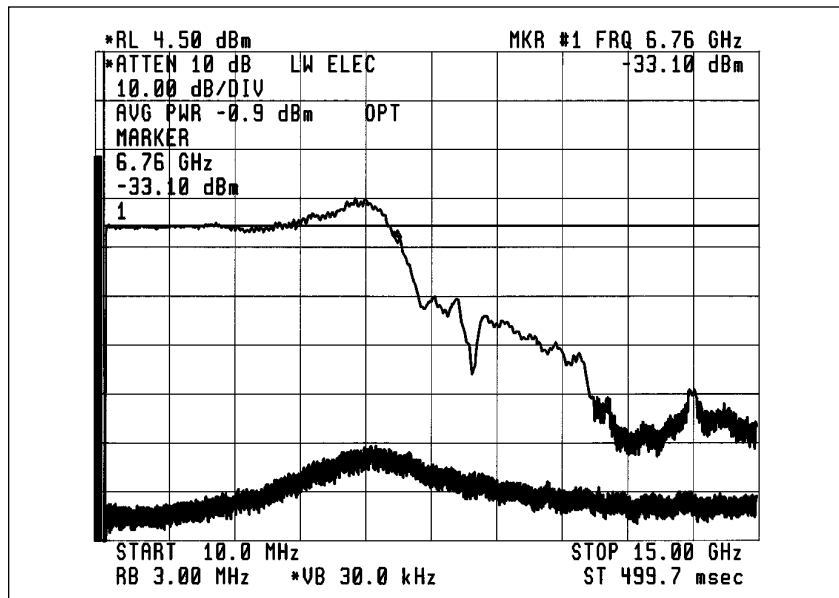

Figure 6. The combined display of the noise floor and frequency response shows two important properties of lasers for high-speed systems.

Relative Intensity Noise

The measurement of relative intensity noise (RIN) describes the laser's maximum available range for signal modulation and serves as a quality indicator of laser devices for both broadband digital or analog systems. RIN is defined as:

$$\text{RIN} = \frac{\langle \Delta P^2 \rangle}{P^2} \text{ dB/Hz} \quad (8)$$

Where $\langle \Delta P^2 \rangle$ is the mean-square optical intensity fluctuations (in a 1-Hz bandwidth) at a specified frequency, and P is the average optical power.

The ratio of optical powers squared is equivalent to the ratio of the detected electrical powers. Thus, RIN can be expressed in terms of detected electrical powers. Equation 8 can be rewritten as:

$$\text{RIN} = \frac{N_{\text{elec}}}{P_{\text{AVG}}(\text{elec})} \text{ dB/Hz} \quad (9)$$

Where N_{elec} is the power-spectral density of the photocurrent at a specified frequency, and $P_{\text{AVG}}(\text{elec})$ is the average power of the photocurrent. The photonic shot noise is not included in the definition of N_{elec} .

With the Agilent 71400C, you can directly measure the RIN of the laser as a function of frequency. This approach provides more information than can be obtained by measuring the laser noise using a band-pass filter and electrical power meter, which integrates all the noise inside the bandwidth of the filter. In addition, because the analyzer is a calibrated receiver with a built-in optical power meter, the Agilent 71400C directly computes RIN.

With the Agilent 71400C, two measurements of RIN can be obtained as a function of frequency: RIN Lasr provides a measurement of RIN of the laser device with shot noise and thermal noise removed from the measurement; RIN SYS provides a measurement of RIN including the shot-noise and thermal-noise contributions measured by the lightwave signal analyzer. (See Product Note 71400-1, Agilent literature number 5091-2196E for a detailed discussion of RIN measurements.)

Frequency Modulated Light

Variation of the optical frequency as a by-product of intensity modulation is a common property of semiconductor laser diodes. This incidental frequency modulation (FM) — sometimes called “chirp” — is illustrated in figure 7. Normally an unwanted side effect, you can exploit this FM characteristic as a method for transmitting information over an optical fiber.

The Agilent 71400C lightwave signal analyzer cannot directly detect frequency modulation. However, it can do so indirectly by the addition of a fiber-optic interferometer (for example the Agilent 11980A), which converts frequency modulation to intensity modulation. Then, the lightwave signal analyzer can measure frequency modulation of single-mode laser diodes.

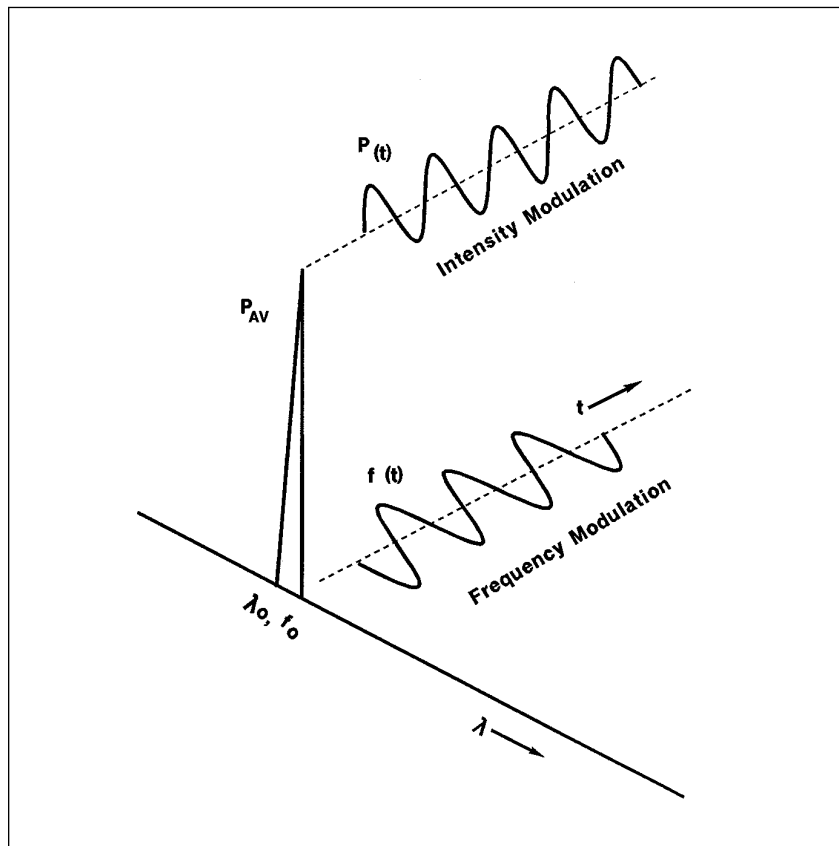

Figure 7. Simultaneous intensity modulation and frequency modulation of a single-mode laser

Figure 8 shows the test configuration for measuring frequency modulation, or chirp, on a single-mode laser. A single-frequency laser, such as a distributed-feedback (DFB) laser with sufficient optical isolation to prevent perturbation by reflected light, is modulated with a signal source. This signal source is gated on and off with a 50 percent duty cycle so that the laser is operating unmodulated for a time, T , and then modulated for an identical time, T . The laser is on at all times; only the modulation is gated. This burst-modulated light passes into a fiber-optic Mach-Zehnder interferometer such as the Agilent 11980A. In the interferometer, a fiber-optic directional coupler divides the incoming power into two parts, P_1 and P_2 . P_1 is delayed for a time, T ($3.5 \mu\text{s}$ in the standard Agilent 11980A, $25 \mu\text{s}$ in Opt 005). Then, it is recombined with P_2 in another optical directional coupler. Thus, the laser under test also functions as both the local oscillator and the modulated laser under-test in this optical homodyne receiver. Recall from figure 2(c) that when two lightwaves at different frequencies combine in an optical directional coupler, an intensity-modulated wave can be detected at both coupler output ports. Equation 10 quantifies the power detected at each output port.

$$P(t) = 1/2 * (P_{1AVG} + P_{2AVG}) + (P_{1AVG} * P_{2AVG})^{1/2} * \cos[2\pi(f_2 - f_1)t] \quad (10)$$

Thus, the intensity-modulated (IM) light contains a signal component at the instantaneous frequency difference, $f_2 - f_1$, between the unmodulated and modulated optical waves, P_1 and P_2 . This shift in the wavelength of the laser due to direct modulation is called “chirp.”

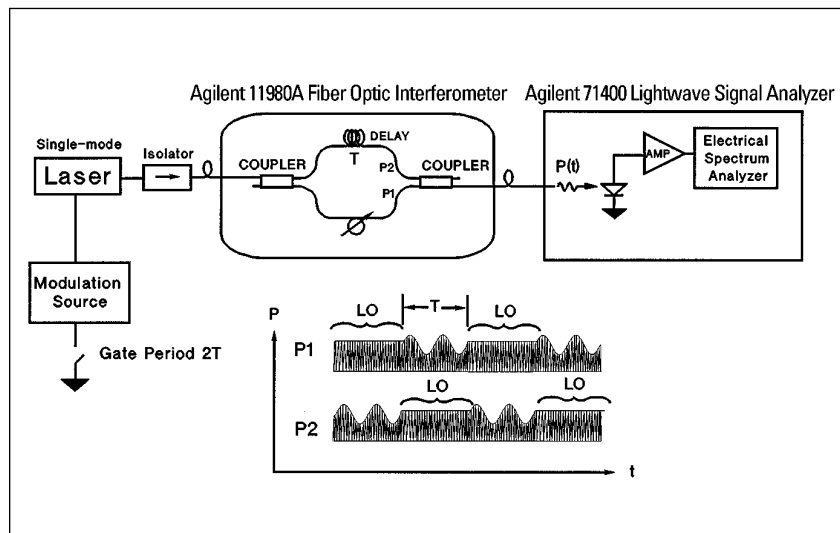

Figure 8. Gated, self-homodyne interferometry

Looking at a time interval during which P_2 is modulated and P_1 is unmodulated, as shown in figure 9, you see simultaneous IM and FM with a sinusoidal modulating waveform at FM. In figure 9(a) the instantaneous frequency, f_2 , deviates above and below f_1 along with the power. You can see both the magnitude of frequency deviation, $f_2 - f_1$, in figure 9(b) and the detected voltage waveform in figure 9(c). This waveform contains high-deviation FM along with the IM. When displayed in the frequency domain by the Agilent 71400C, the IM shows the full modulation spectrum of IM and FM sidebands in figure 9(d).

This modulation spectrum contains a strong component at $FM = f_2 - f_1$, which is a combined IM and FM signal. The higher-order harmonics are generated by the fundamental nonlinearity of the FM process, which can be predicted by standard Bessel-function FM theory. Each FM signal component can thus be resolved to a bandwidth equal to twice the unmodulated linewidth of the DFB laser, allowing the linewidth of the laser to be measured under low-level modulation. The IM that both feeds through the interferometer and is directly detected by the Agilent 71400C is readily distinguished since it is resolved by the narrower resolution bandwidth of the electrical spectrum analyzer.

By analogy to microwaves, and as shown in figure 8, the laser in its unmodulated state can be thought of as the “local oscillator,” the laser in its modulated state as the “signal,” and the optical coupler and photodetector as the “mixer.” The preamplifier and spectrum analyzer can be viewed as the “baseband” portion of a homodyne receiver. This method of optical IM/FM detection is called gated delayed self-homodyne spectrometry.⁴

For asymmetric spectra, the folding-over associated with the homodyne process confuses the interpretation. However, useful information can still be obtained.⁵

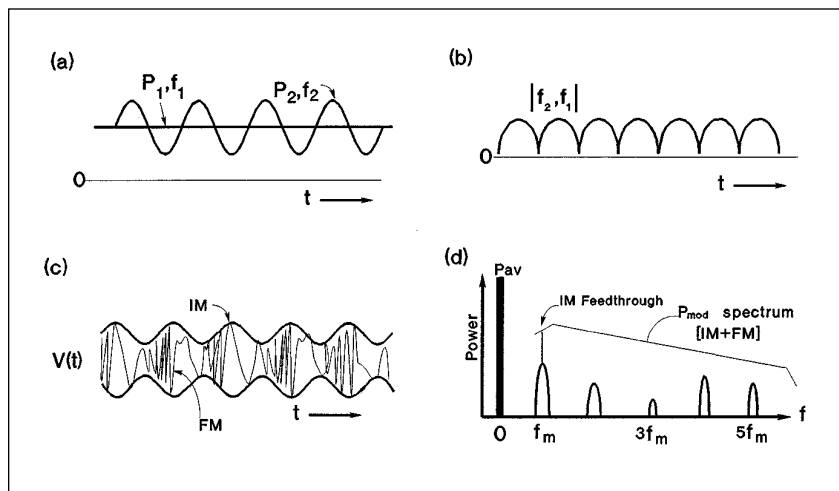

Figure 9.

(a) Frequency deviation and intensity modulation of P_1 and P_2 in the Agilent 11980

(b) magnitude of frequency deviation

(c) detected voltage in the time domain

(d) Agilent 71400C frequency-domain display of FM and intensity modulation (IM) components.

For the special case of an unmodulated laser, the technique reduces to delayed self-homodyne spectrometry,⁶ a method commonly used for measurement of unmodulated laser linewidths. Figure 10 illustrates the process of homodyne autocorrelation as it applies to the ideal case of Lorentzian lineshapes. Self-homodyning can be described mathematically as a single-delay autocorrelation. The optical spectrum at f_0 autocorrelates with the delayed version of itself to produce a time-fluctuating spectrum, whose detected voltage has a power spectrum centered at zero frequency. For the case of a laser with Lorentzian lineshape, the half-width of the detected spectrum is equal to the linewidth of the laser. When displayed in electrical power units, the homodyne spectrum is Lorentzian, with a half-width equal to the linewidth of the laser under test.

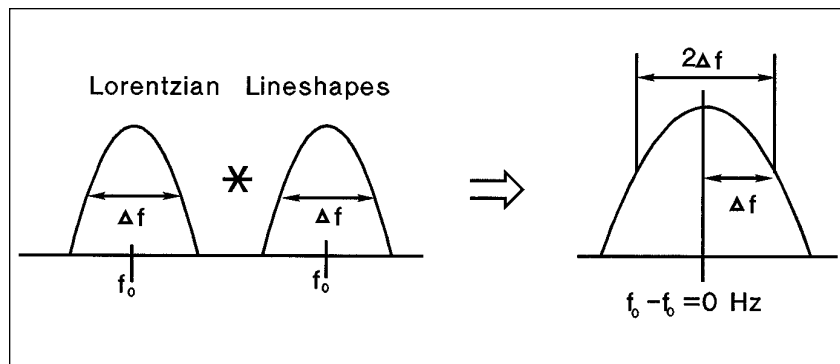

Figure 10. Linewidth of a DFB laser using the self-homodyne technique

For lineshapes other than Lorentzian, Gaussian for example, the homodyne spectrum will replicate the laser lineshape if the function (shape) is invariant under autocorrelation. Therefore, you should recognize that the delayed self-homodyne linewidth measurement technique is strictly correct only for the ideal laser; that is, one with a Lorentzian lineshape.

References

1. T.S. Tan, R.L. Jungerman, S.S. Elliot, "Calibration of Optical Receivers and Modulators Using an Optical Heterodyne Technique," IEEE - MTT-S International Microwave Symposium Digest, 00-1, 1988, pp. 1067-1070
2. Harold Sobol, "The Application of Microwave Techniques in Lightwave Systems," J. Lightwave Technol. vol. LT-5, no.3, March 1987, pp. 293-299.
3. D.J. Derickson, C.M. Miller, R.L. VanTuyl, "A 100 kHz to 22 GHz Instrumentation Photoreceiver," IEEE -MTT-S International Microwave Symposium Digest, 00-1, 1988, pp 1063-1070.
4. D.M. Baney and W.V. Sorin, "Measurement of a Modulated DFB Laser Spectrum Using the Gated Delayed Self-Homodyne Technique," Electronics Letters, vol. 24, no. 11, May 26, 1988, pp. 669-670.
5. D. Baney, P. Gallion, "Homodyne Study of DFB Laser Chirp for Symmetric and Asymmetric Modulation Spectra," OFC Digest, WQ 19, Feb. 1989.
6. T. Okoshi, K. Kikushi, A. Nakayama "Novel Method for High Resolution Measurement of Laser Output Spectrum," Electronics Letters, 1980, vol. 16, 1980, pp. 630-631.
7. C. Miller, D. Baney, L. Stokes, "Enhanced Intensity Noise and Spectral Measurements on Lasers Using Lightwave Signal Analyzers," Agilent RF, Microwave, and Lightwave Symposium, 1990.

Chapter II

Using the Lightwave Signal Analyzer

System Description

The Agilent 71400C and Agilent 71401C lightwave signal analyzers combine a special photoreceiver module, the Agilent 70810B lightwave section, with other Agilent 70000 modular measurement system (MMS) plug-in modules. This combination is used to configure lightwave signal analyzer systems, as shown in figure 11.

Modulated light enters the lightwave section through a single-mode fiber front-panel connector. Here, it is expanded, collimated, and then focused onto a PIN photodetector. The collimated beam passes through an optical attenuator (controllable over a 30-dB range in 1 dB steps), which can be used to prevent front-end overload. Photons are absorbed in an InGaAs photodetector, for the standard Agilent 70810B, and in a GaAs photodetector for Option 850. Electron-hole pairs are generated by the light, producing the photocurrent.

The dc photocurrent flows to the power-monitor circuit, which measures the integrated, or average, optical power. The ac photocurrent flows to the 50-ohm input, 100-kHz to 22-GHz preamplifier. This amplifies the signal by 32 dB to improve the sensitivity of the analyzer. The combined frequency response of the photodetector, preamplifier, and spectrum analyzer is measured during production.

The calibration and correlation data at hundreds of frequency points from 100 kHz to 22 GHz are stored in the analyzer as correction factors.* Using these correction factors, the system controller corrects each modulated power measurement at all frequencies from 100 kHz to 22 GHz before the information is displayed.

You can also use a tracking generator from the Agilent 70000 modular measurement system to provide a swept modulation source whose frequency is synchronized with the sweep of the spectrum analyzer. With a tracking generator, you can use the system to conveniently generate frequency-response measurements for lightwave sources and detectors. Figure 5 (see chapter 1) shows such a measurement.

* The Agilent 70810B contains stored corrections for its photodetector and preamplifier. When placed in an Agilent 70000 spectrum analyzer system, additional calibration and accuracy for systems interaction is available with the Agilent 70810B Option 020. The Agilent 71400C and Agilent 71401C includes this option as standard.

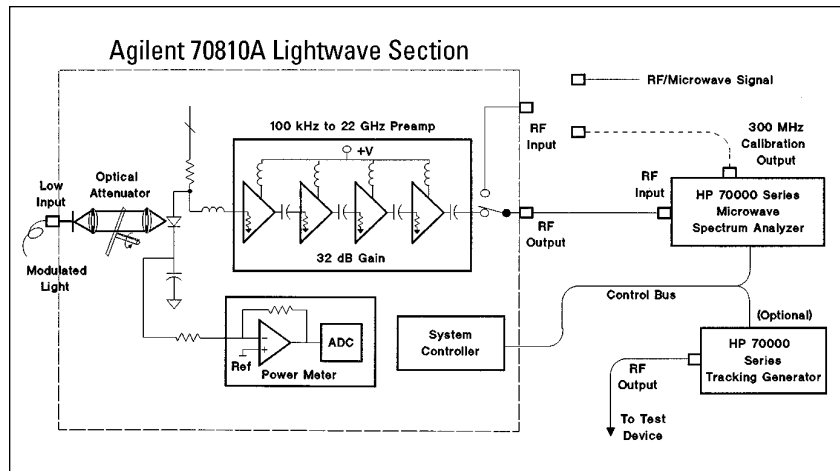

Figure 11. Lightwave signal analyzer system

Operation

During the power-up cycle, the lightwave signal analyzer passes to the spectrum analyzer the many correction factors stored in the lightwave module that are used to correct the display. The system also prepares to accept commands through the control keys **USER**, **MENU**, and **DISPLAY**.

Electrical Calibration

The instrument should be electrically calibrated after warm-up. This is done by connecting the 300-MHz calibration signal from the Agilent 70900B local oscillator to the RF input of the lightwave section, then pressing **MENU**, **Amptd**, and **CAL ALL**. An automatic calibration routine runs, and the instrument stores the correction factors for IF gain, reference accuracy, and other electrical parameters until the next calibration occurs. The **UNCOR** message will light on the screen when any module is changed in the system to remind you of the need to recalibrate.

Connector Cleaning

IMPORTANT PRECAUTION: Before attaching a fiber-optic cable to the input of the lightwave section, always clean the cable connector and the front-panel input connector. Using soft lens tissue, wash the connectors with a solvent such as isopropyl alcohol, then remove any particles with the special tape provided in the cleaning kit. Cleaning ensures the best possible input return loss and helps prevent costly connector damage. Use of index-matching fluids or gels is not recommended.

Main Menu

Access control functions shown in figure 12(a) by pressing **MENU** and then selecting the area of interest from the firmkey menu, for example **Marker**. As shown in figure 12(b), the individual control functions appear on the right-hand menu softkeys, often arranged in several pages. Note that the left-hand firmkey is underlined, showing which group is selected, and the right-hand menu key, or active function, is highlighted. Many functions allow an associated numerical input, as in the case of **BW, Swp, Marker, START/STOP FREQ**, and **SWPTIME**. You can input numerical entries via the keypad, the rotary knob, or up- and down-arrow keys.

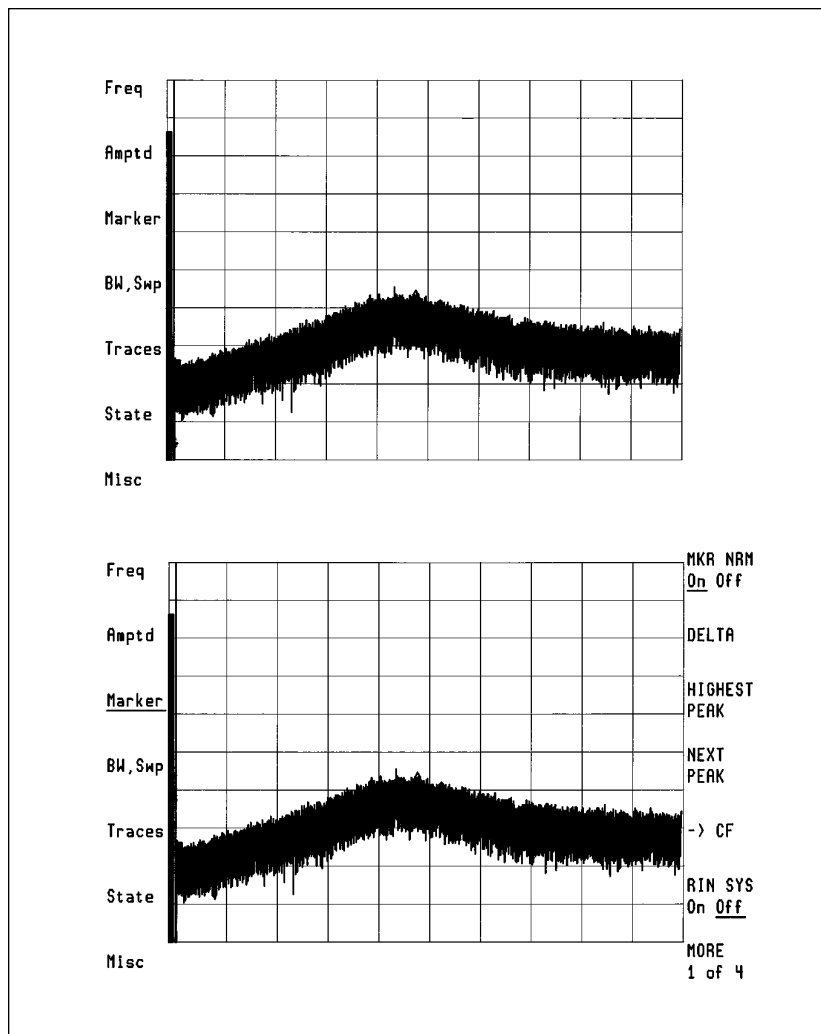

Figure 12. (a) Main menu

Figure 12. (b) Marker menu functions

User-Defined Menu

For convenience, you can define custom menus by pressing **USER**. To redefine any of the user menu keys, press **DEFINE USR KEY** and then press **MENU**. Locate the desired function in the **MENU** tree, then return to **USER** and press the location where you wish the function to appear. This allows you to locate frequently used control functions on a single page, for easy access. Figure 13 shows a sample **USER** Menu.

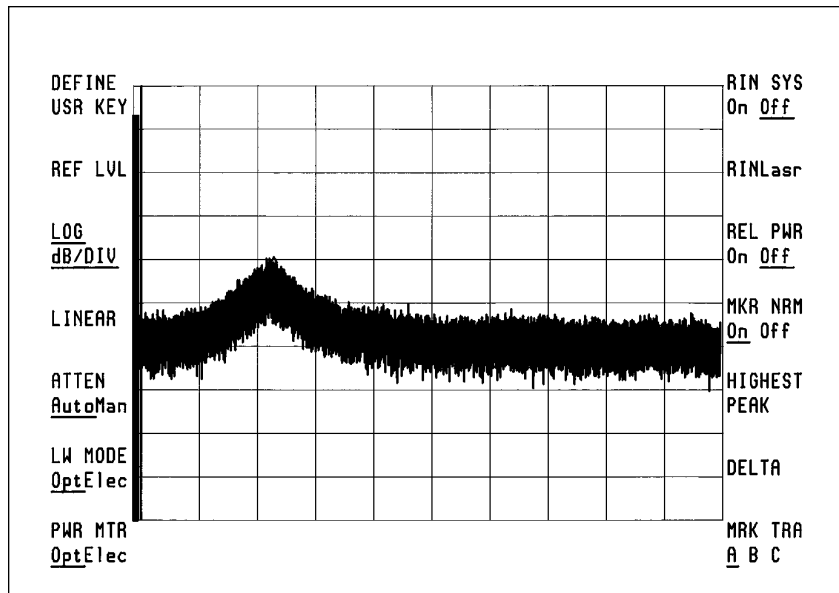

Figure 13. User menu

Operating Modes

Lightwave Modes

The lightwave signal analyzer provides the flexibility to display the lightwave input signal in true optical units, **LW MODE Opt**, or as the equivalent electrical power produced by the internal photodiode, **LW MODE Elec**. **LW MODE Elec** also allows you to emulate any responsivity, r_v (volts/watt), that would appear on a separate microwave spectrum analyzer with external photoreceiver. **LW MODE Elec** is useful for measuring the modulation response of photodetectors and laser sources when normalization relative to an electrical port is necessary (such as when tracking generators are used). To switch the display between modes, press **MENU, Amptd, MORE, LW MODE Opt Elec**.

The built-in optical average-power meter readout lets you select between optical and electrical units independent of the display mode; press **MENU, Amptd, MORE, power meter, PWR MTR Opt Elec**. Thus, electrical display units could be used for modulation response measurements while monitoring the average power in optical power units.

The **LW MODE Opt** allows you to measure the lightwave input in optical dBm or watts. The **LW MODE Elec** allows you to measure the lightwave input in electrical dBm, watts, dBmV, dBuV, and volts.

With the lightwave modes, you can measure the following parameters:

Optical or detected electrical average power
Modulated optical or detected electrical power
Relative power (P_{MOD}/P_{AVG})
Optical or electrical detected intensity noise
Input-noise-equivalent power of the instrument
Relative intensity noise, or RIN, (independent of mode selection)
Bandwidth in optical or electrical dB

To calibrate the detector for the wavelength band of interest, press **MENU, Amptd, MORE, and LAMBDA**. You can select 1300 nm or 1550 nm as required for the standard Agilent 70810B or 850 nm for Option 850. If you wish to calibrate relative to an external power-meter standard, measure the average power in your single-mode fiber-optic cable with a calibrated, external optical power meter such as the Agilent 8153A. Attach the fiber-optic cable to the “Optical Input” connector. Press **MENU, Amptd, MORE, power meter, USR PWR ON**, enter the offset power level via the numeric keypad, and select the proper terminator softkey. An asterisk will appear next to the AVG PWR annotation when the **USR PWR** function is activated.

Bypass the Lightwave Input

To perform measurements of electrical power that normally would be made with a microwave spectrum analyzer, you need to bypass the optical input on the Agilent 70810B. Simply attach the electrical signal to the “RF Input” connection on the front panel of the lightwave module. Then press **MENU, State, select input, IN 2 μ W 70810B**. The signal will bypass the lightwave section and connect directly to the spectrum-analyzer input. Notice that the specific menus for the lightwave signal analyzer will no longer be present in the menus.

Measurement Example

The following example demonstrates a useful measurement that uses the **LW MODE Opt, LW MODE Elec**, and the optical bypass configuration available in the lightwave signal analyzer. Assume that you need to characterize a laser diode for use in a fiber-optic communication system and that you also need to measure the harmonic distortion due to the nonlinearity of the laser.

First, set up the test equipment as shown:



Next, check the harmonic distortion of the signal generator. Do this using the optical-bypass configuration in the Agilent 71400C with the RF signal connected directly to the RF input. Be sure that the harmonic distortion is well below the level you expect from the laser at its test drive-power level. If not, measurement errors could result.

Next, connect the laser transmitter output to the Agilent 71400C optical input and select **IN 1 LW 70810B**. You can check the average optical power using the built-in optical power meter (AVG PWR annotation and power bar). If this level is not what you expect, check the fiber cables, connectors, and lightwave transmitter.

Finally, connect the signal generator to the laser transmitter input, and switch the lightwave signal analyzer to **LW MODE Elec**. A display similar to figure 14 appears (This example is repeated as “Measurement Example #2” in chapter 3.)

Before continuing with this example, take a moment to become familiar with main features of the display.

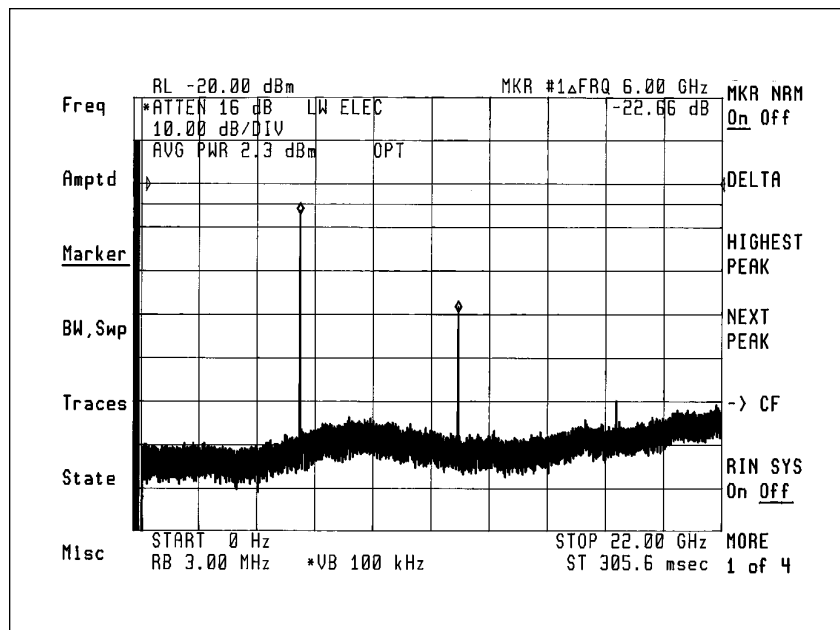

Figure 14. Agilent 71400C sample display

Menu: The left and right margin entries define the functions for the menu keys. The left keys are firmkeys, whose functions remain fixed. The right-hand keys are the soft keys, which control the instrument. As an example, push **Amptd**. Note that the **Amptd** becomes underlined and the set off functions associated with amplitude appear on the right side of the screen.

Reference Level [RL -20 dBm]: This function defines the power level represented at the top of the display. Select it either manually or automatically. To avoid visual conflict between the display and the annotation, the reference-level position may be moved, for example, to the second division from the top. Push **Amptd**, **MORE**, **REF LEL POSN** and enter “8.” This will shift the signal level (apparent reference level) two divisions down, without changing any other parameter.

Attenuation [ATTEN 16 dB]: This feature shows the automatically selected optical-attenuator setting. You can now manually enter another attenuation setting. If you push the **MARKER** firmkey, the list of marker options appears for the keys on the right side of the screen.

Marker Delta [MKR #1 FRQ 6.0 GHz, -14.2 dBm]: This feature shows the frequency and power difference between the two diamond-shaped markers. Selecting the top key of the right-hand marker menu set causes the marker to return to normal (only one marker on; delta function off) and to turn off all marker functions.

Active Parameter: Note that the active-parameter window in the display tells which menu function is activated and which numerical value (or values) are associated with it. You can numerically modify the **active parameter** via the up/down keys, the rotary knob, or the numeric keypad.

Let's now continue with the measurement example. To reduce the width of the noise-baseline display, you may reduce the video bandwidth. This could be done by pressing **BW,Swp, VID BW Man** and using the down-arrow; instead, press **MORE** twice and then press **VBW/RBW RATIO**. Next, key in .01, and press **Enter**. This will reduce and preserve the ratio of video filtering and keep a similar noise trace-width display, regardless of the resolution bandwidth selected.

You can leave the resolution bandwidth at 3 MHz, its maximum setting, because the signal is much greater than the noise. This assures the fastest possible sweep time. To maintain amplitude calibration, the analyzer automatically slows the sweep when a lower resolution bandwidth is selected.

The display will show the intensity noise of the laser, the average power, and the modulation components (signal plus its associated harmonic distortion). To measure the harmonic distortion, press **Marker, HIGHEST PEAK** (this places the marker on top of the strongest signal), **DELTA**, and **NEXT PEAK** (which places another marker on the next strongest harmonic and measures the amplitude and frequency difference between the two markers). The marker-annotation section now shows the harmonic distortion (-22.66 dB in this case). Now, check for distortion induced by the analyzer. Increase the input attenuation by pressing **Amptd, ATTEN, Man**, and the up-arrow key. If the harmonic distortion does not change, lightwave-signal-analyzer distortion is not contributing to the measurement.

Now by returning to **LW MODE Opt**, you can measure the depth of modulation of the laser by reading the relative power (the ratio of signal power to average power) via the **REL PWR** marker function. This function measures the difference between the power bar and the signal. The measurement is expressed either in dB or as a linear ratio.

This sample measurement is listed, along with many others, in chapter 3, as Measurement Example #2.

Chapter III

Agilent 71400C Measurement Examples

This section presents examples of many lightwave measurements that can be performed with the Agilent 71400C lightwave signal analyzer. In each example, you see the keystroke sequence used to generate the measurement. References to specific function keys and operating modes appear in **bold letters**. For a discussion of accuracy and system error analysis, please refer to Application Note 150, "Spectrum Analysis Basics," revised 1988 (Agilent Lit. No. 5954-9130).

After performing these measurements, you will probably want to save some of the setups for future recall using the **SAVE STATE** feature. To do so, make sure the state register is unprotected (**PSTATE Off**), then press **SAVE STATE**, key in a number 1 through 8, or as selected in **NSTATE**, and press **ENTER**. The instrument setup state will be saved. It can be protected by pressing **PSTATE On**. To recall the saved state for later use, press **RECALL STATE**, the number of the saved state, and **ENTER**.

All measurements were made on a distributed feedback (DFB) laser. Therefore, the annotation and screen information shown reflect a specific setup for this laser. Your measurements will often require adjustments to **fit** the specific applications and devices under test. These examples are intended to present ideas for using the lightwave signal analyzer.

For additional information on the modular-measurement-system menu, please refer to "Users Guide: Agilent 70000 Modular Measurement System. A Self-Paced Tutorial for Front Panel Operation," Agilent Literature Number 5954-9142.

Agilent 71400C Measurement Example #1 Modulated Laser Power

Measurement: Display modulated power from a semiconductor laser diode. Measure modulated power relative to the average power of the lightwave signal. Relative Power = P_{MOD} / P_{AVG} .

Setup:

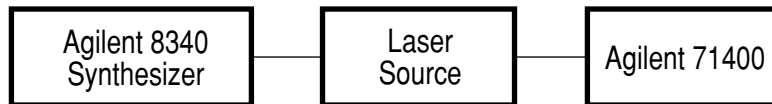

Menu Selection Sequence: IP

Amptd; REF LVL [7 dBm], ATTEN [6 dB], units menu, WATT
 Marker; HIGHEST PEAK, more, REL PWR ON
 Agilent 8340; CW mode, Freq = 5.0 GHz (or frequency of interest), power level [5 dBm]

Comments: This example demonstrates the basic measurement of modulated optical power, so you set up the measurement in **LW MODE Opt** (power-up default). Choose a reference level of 7 dBm. The marker chosen reads out relative power (P_{MOD}/P_{AVG}) in linear units because **WATT** was chosen for the units. However, the display is still a logarithmic scale (in dB units). The relative-optical-power modulation index, “m”, is about 0.144 or 14.4%.

Set the optical attenuator so that the signal does not exceed the non-graticule horizontal line onscreen. This ensures that the input of the RF section following the lightwave section is not overloaded. The **ATTEN Auto** function guarantees linearity for all modulated powers below the reference level.

Display:

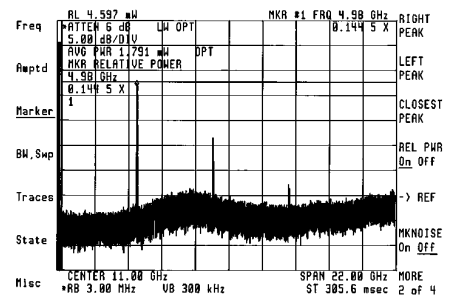

Agilent 71400C Measurement Example #2: Detected Electrical Power

Measurement: Use the **LW MODE Elec** to display power from a modulated laser and measure harmonic distortion.

Setup:

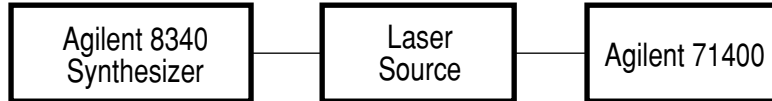

Menu Selection Sequence: IP

Amptd; more, LW MODE Elec, more, more, REF LVL [-20 dBm] or as required for power output of laser, ATTEN [8 dB], more, REF LVL POSN [8] (to center display information)
 Marker; HIGHEST PEAK, DELTA, NEXT PEAK
 Agilent 8340; CW mode; Freq = 6.0 GHz, RF power output [5 dBm]

Comments: Here, you measure the harmonic distortion generated by the nonlinearity of the modulated laser. This parameter is often measured after the optical signal has been detected and amplified.

LW MODE Elec adjusts the displayed information to read out in units of electrical dB rather than optical dB. This mode is used when comparing measurements on lightwave signals to measurements made on electrical, microwave, or RF signals. For each measurement mode, appropriate correction and calibration factors optimize the accuracy.

Making sure that the modulation power does not exceed the non-graticule horizontal line onscreen ensures that a modulated signal below the reference level will not overload the input.

You can offset the reference level two divisions for display clarity. The **marker-delta** function measures the second harmonic distortion (-22.66 dB, in this example). To verify that the lightwave signal analyzer is not introducing observable harmonic distortion, you can use the **ATTEN** key to temporarily alter the attenuator setting. You can be sure that the measurement is accurate when the distortion measurement remains unchanged for an increase in attenuation value.

Display:

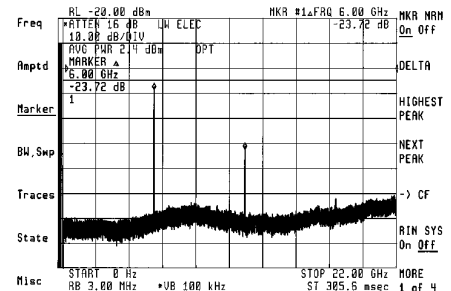

Agilent 71400C Measurement Example #3: Low-level Signals

Measurement: Measure very low modulated power.

Setup:

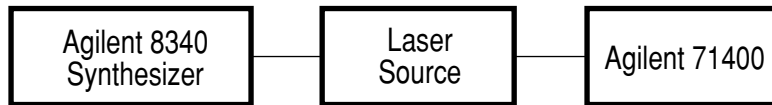

Menu Selection Sequence: IP

Freq; CENTER [2.0 GHz], SPAN [500 Hz]
 BW, Swp; RES BW [10 Hz], VID BW [30 Hz], VID AV[10]
 Amptd; REF LVL [-50 dBm, or as required],
 LOG dB/DFV [1 dB], ATTN [0]
 Marker; HIGHEST PEAK
 Agilent 8340; CW mode, Freq [2 GHz] RF power [about
 -96.0 dBm]. (Lock the time base of the Agilent
 8340 to the Agilent 71400C for accurate
 readings by connecting the Agilent 70310A
 modules “10 MHz out” to the external reference
 input of the Agilent 8340.)

Comments: You can measure very low levels of modulated optical power by reducing the **resolution bandwidth** to the point where displayed noise is reduced below the signal of interest. The Agilent 71400C has a typical noise equivalent power of less than -70 dBm (opt)/Hz. Displayed noise increases 5 db(opt) per decade increase in resolution bandwidth, so the minimum displayed noise is typically less than -65 dbm(opt) for the 10-Hz resolution bandwidth.

You can obtain further signal enhancement by using a **video bandwidth** equal to 3 Hz or by using **video averaging**. This example shows a modulated power of -59.80 dBm with an average power of 1.5 dBm. Ten traces were averaged to produce this measurement. The **autozero** function corrects for power-meter drift at 60-second intervals. Alternatively, you can press the **ZERO** softkey (**Amptd, more, power meter, ZERO**) just before the measurement to ensure best average-power accuracy.

Display:

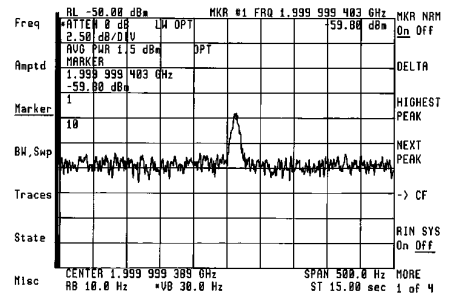

Agilent 71400C Measurement Example #4: Relative Intensity Noise (RINLasr)

Measurement: Measure relative intensity noise of a laser source, RIN (laser).

Setup:

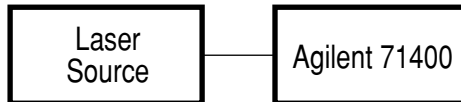

Menu Selection Sequence: IP

Freq; Start [0 Hz] (or as required), Stop [5 GHz] or as required)
 BW, Swp; VID BW [10 kHz]
 Amptd; REF LVL [-15 dBm or as required], ATTEN [0 dB]
 Marker; MKR NRM [1 GHz or at frequency of interest]
 USER; RINLasr

Comments: The measurement of relative intensity noise (RIN) describes the laser's maximum available amplitude for signal modulation and serves as a quality indicator of laser devices. The lightwave signal analyzer has two built-in **RIN** functions: **RINLasr** (described in this example) and **RIN SYS**. (See example #5.)

The **RINLasr** is a downloadable program (DLP) that provides the ratio of the laser noise (lightwave-signal-analyzer shot and thermal noise removed) to average power. To use this function, first configure the instrument. The RIN (Laser) measurement is independent of display or power-bar units (**LW MODE Opt, PWR MTR Opt** used in this example). Select as low an attenuation as possible without + 3 dBm optical power reaching the photodiode. Since the laser average power was 2.2 dBm in this example, 0 dB attenuation was selected.

The **DLP** is accessible under the USER menu key; it is activated by pressing the **RINLasr** softkey. The data window displays four lines of information. The top line, **RIN (Laser)**, provides the measurement result. The second line, **RIN (System)**, provides the **RIN** of the laser with the shot-noise and thermal-noise contributions still present. The third and fourth lines present the thermal-noise and shot-noise contributions that are subtracted to obtain the **RIN (Laser)** value. The subtraction of these terms is performed using linear units. The RIN (Laser) value of -153.47 dB/Hz is shown, which is a 3.94 dB measurement improvement.

Display:

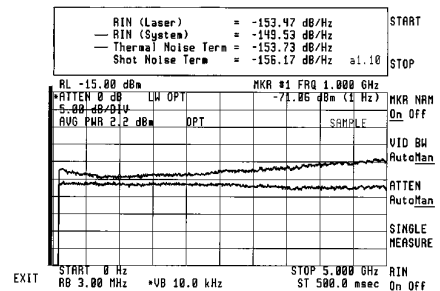

The dynamic range of the **RINLasr DLP** is limited by the maximum detectable average power and the noise floor of the analyzer. In addition, the DLP subtracts the contributions of the shot and thermal noise up to a limit of 16 dB over the RIN (System) value. This limit is imposed due to a measurement uncertainty that can result when taking the difference of two noise measurements whose values are close to one another. If this limit is reached, a superscript will be displayed after the RIN (Laser) values, indicating that the laser has a RIN of the value displayed or better. The following table gives minimum values of RIN (Laser), for a given optical average power, calculated from the Agilent 71400C specifications.

Frequency Range	3 dBm Power	0 dBm Power	-5 dBm Power
10 MHz – 100 MHz	-157 dB/Hz	-151 dB/Hz	-141 dB/Hz
100 MHz – 16 GHz	-165 dB/Hz	-159 dB/Hz	-149 dB/Hz
16 GHz – 22 GHz	-153 dB/Hz	-147 dB/Hz	-137 dB/Hz

See Product Note Agilent 71400-1 Lightwave Signal Analyzers Measure Relative Intensity Noise, literature number 5091-2196E, for a full discussion of RIN.

Agilent 71400C Measurement Example #5: Relative Intensity Noise (RIN SYS)

Measurement: Measure relative intensity noise of a laser receiver system, RIN SYS.

Setup:

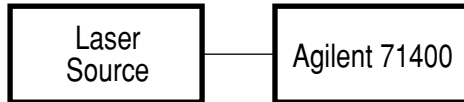

Menu Selection Sequence: IP

Freq; Center [11 GHz], Span [22 GHz] (or as required)
 BW, Swp; VID BW [30 kHz]
 Amptd; REF LVL [-1.5 dBm or as required],
 ATTEN [0 dB]
 Marker; MKR NRM [2.5 GHz or at frequency of
 interest], RIN SYS On
 Trace; STORE A (to save the laser noise). Disconnect
 the laser then push TRACE B, CLR WRT B to
 display the instrument's noise floor.

Comments: RIN SYS measures the total system noise (laser intensity noise, plus detection shot noise, plus thermal noise of the analyzer) to the average laser power. The measurement result is displayed as the ratio of equivalent electrical terms, regardless of the units displayed. A wide span is useful for viewing the full laser system response and for determining frequencies for optimum system operation and signal-to-noise ratio.

The **RIN SYS** function is adequate for determining **RIN** of most Fabry-Perot lasers and provides a speed advantage to the **RINLasr DLP**. (See example 4.) The following table gives minimum values of **RIN SYS**, at a given optical average power level, calculated from the Agilent 71400C specifications.

Frequency Range	3 dBm Power	0 dBm Power	-5 dBm Power
10 MHz – 100 MHz	-141 dB/Hz	-135 dB/Hz	-125 dB/Hz
100 MHz – 16 GHz	-149 dB/Hz	-143 dB/Hz	-133 dB/Hz
16 GHz – 22 GHz	-137 dB/Hz	-131 dB/Hz	-121 dB/Hz

Display:

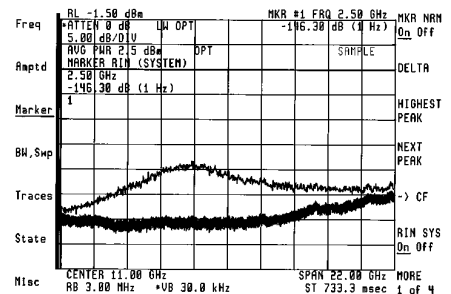

Agilent 71400C Measurement Example #7: Modulation Linearity of Laser Diode

Measurement: Display the modulated optical power (dB optical) versus modulated electrical power (dB electrical) of a laser. Determine the modulated-power linearity.

Setup:

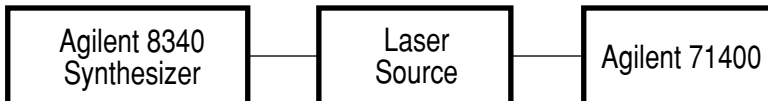

Menu Selection Sequence: IP

Freq; CENTER [2 GHz] (trace A), 6 GHz (trace B),
 100 MHz (trace C), SPAN [0 Hz]
Amptd; REF LVL [3 dBm], LOG DB/DIV [1 dB] (to
 enhance display of linearity)
BW,Swp; RES BW [1 MHz], SWPTIME [100 ms],
 TRIGGER VIDEO, VIDEO LEVEL (Adjust as
 required to center display as shown)
Agilent 8340; 2 GHz and 6 GHz, POWER LEVEL [-5 dBm],
 POWER SWEEP 20 dB/SWP, SWEEP TIME
 [100 ms]

Comments: You can use the Agilent 71400C as a fixed-tuned receiver with triggered time base. This allows you to measure the time variation of power at a selected frequency. When coordinated with the power-sweep feature of a synthesized sweeper, such as the Agilent 8340B, the time axis becomes an input-power (dB) axis. Thus, you can plot modulated optical power (dB optical) versus modulated electrical power (dB electrical), and you can make inferences regarding the linearity of the laser's modulation transfer function.

In this case, the Agilent 8340B has been set for 20 dB/100 ms, so the horizontal axis is 2 dB/div. As expected, the laser responds at 1 dB (optical) per 2 dB (electrical) for low modulation levels at 2 GHz. However, there is a gradual departure from linearity for f_{mod} equal to 6 GHz. Clearly, the signal distortion for this laser is frequency dependent.

Display:

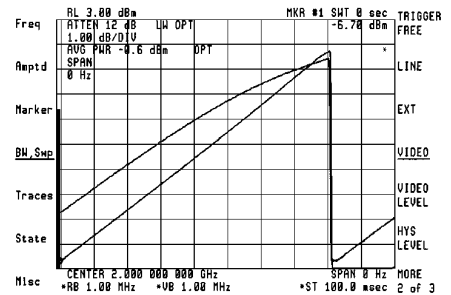

Agilent 71400C Measurement Example #8: Pulsed Laser Modulation Spectrum

Measurement: Display modulated power from a pulsed semiconductor laser diode.
Show frequency-domain envelope of pulse spectrum.

Setup:

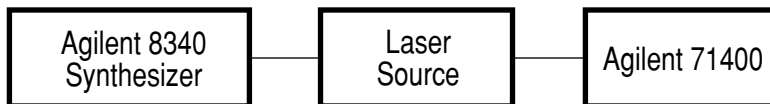

Menu Selection Sequence: IP
 Amptd; REF LVL [8.5 dBm] or as needed, more REF LVL POSN [8]
 Marker; HIGHEST PEAK, REL POWER
 Agilent 8340; CW mode, Freq = 550 MHz, RF power [12 dBm] (or as needed to safely “over-drive” the laser)

Comments: In this example, the semiconductor laser is overdriven; the current dips below lasing threshold for part of a cycle. When this happens, the laser pulses on sharply, overshoots, and rings. A waveform of this sort produces the frequency-domain display shown above.

In this display, the individual spectral lines are at $n * f_{MOD}$, and the envelope traced by the peaks of these lines is the Fourier transform of the pulse shape. In this instance, the relative power is positive in dB (i.e., $m > 1$), a situation that can never occur for a purely linear sinusoidal modulation. However, for pulsed modulation, the average power is no longer midway between the peak and lowest exponential values. In the limit, the ratio of peak power to average power can be very large, and individual frequency components of modulation can be as much as 3-dB above the average power.

Caution: High ratios of peak power to average power encountered in pulse waveforms can overdrive the analyzer input, even in **ATTEN** Auto mode. Be sure always to check for linearity by increasing the attenuator to a setting in which the spectrum shape or amplitude does not vary with attenuation.

Display:

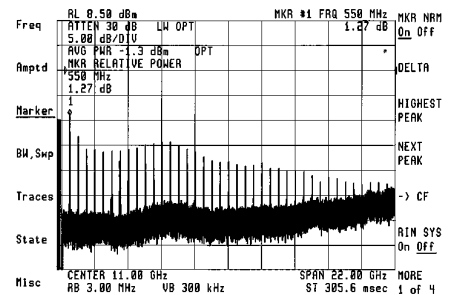

Agilent 71400C Measurement Example #9: PRBS Digital Modulation Spectrum

Measurement: Display modulated power from a semiconductor laser modulated with a pseudo-random binary-pulse sequence.

Setup:

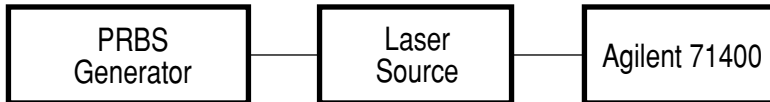

Menu Selection Sequence: IP

Set up the lightwave analyzer as shown for each of the two displays.

PRBS Generator; 565 Mbit/sec NRZ.

Comments: These displays show both the broad-sweep envelope and the narrow-sweep, fully resolved frequency spectrum for pseudo-random binary-sequence (PRBS) intensity modulation applied to a laser diode.

The broad sweep provides an indirect measurement of average pulse shape because the spectrum is the Fourier transform of that pulse shape. By comparing the PRBS envelopes at fiber input and output, you can detect distortion caused by transmission through a fiber. You can also see an undesirable feature, the clock feedthrough at 565 MHz and its harmonics.

The narrowband sweep shows the resolved signal components in the presence of two different levels of laser intensity noise. Each noise level results from different polarizations of reflected light. The best obtainable signal-to-noise ratio (and therefore the best bit error rate) is related to the ratio of signal to integrated noise in the interval between adjacent signal components. The signal level may remain constant while the intensity noise varies. Thus, you can measure and analyze transmitter-related noise problems, even under conditions of large-signal digital modulation. This is very difficult using other measurement techniques.

Display:

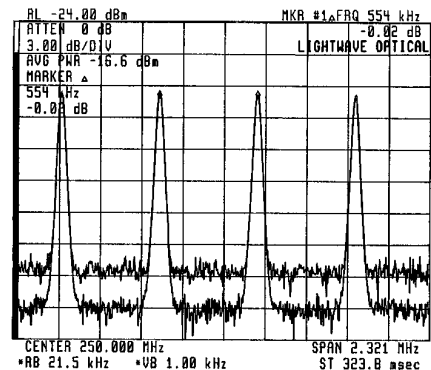
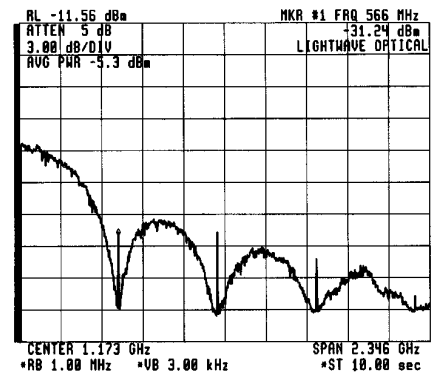

Agilent 71400C Measurement Example #10: Frequency Response and Intensity Noise

Measurement: Without a tracking generator, display the frequency response and intensity noise of a laser diode.

Setup:

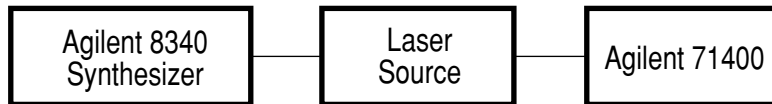

Menu Selection Sequence: IP

Freq; START [10 MHz], STOP [12 GHz]
 Amptd; more, LW MODE Elec, more, more, REF LVL
 [As required], LOG dB/DIV [6 dB]
 Bw,Swp; Vid BW [10 kHz for frequency response trace (B),
 100 kHz for noise trace (A)]
 Traces; MAX HOLD B (Frequency response), CLEAR WRT
 A (Noise)
 Agilent 8340; CW mode, Freq step = 1 GHz, manually stepped

Comments: First, generate a frequency-response graph by using the **max hold** feature while stepping the synthesizer in 1-GHz steps before each sweep. The noise floor also is subject to **max hold**, so it does not accurately depict average noise. After pressing **STORE B** to save the frequency response plot, turn off the modulation, switch to trace A, and press **CLEAR WRT A**. By increasing the video bandwidth by 10 times, you widen the noise trace to the point where it covers the peak noise floor of trace B. A composite frequency response and noise display results. A lower (1 kHz or less) starting **video bandwidth** may be used if a smoother ending noise trace is desired. Note: This measurement is easier if a tracking-generator module is available.

If a tracking-generator module is not available, and a continuous response is desired, it can be achieved by using a sweeping synthesizer such as the Agilent 8340. With the analyzer set on **MAX HOLD A**, set the frequency limits on the sweeper to the desired range (or tune manually). Set the sweep time of the generator to a value at least 10 times the sweep time of the analyzer. Often, a prime number, such as 43 or 59, or a prime-number multiple will fill the display faster. After a few minutes, the trace will fill in with the frequency response of the laser.

If a correction for the frequency response of the electrical source is desired, save the current state, then connect the signal generator to the RF input of the lightwave module and select **IN 2 μ W 70810B**. Using **MAX HOLD B**, press **STORE B**, then press **CLEAR WRT A**. Connect the signal generator to the laser, recall the previous state, and turn on **MAX HOLD A**. You may turn on **DSP LIN** and place it at the maximum amplitude point of trace B. Press **A-B+DL->A**, for the corrected laser frequency response. (See measurement examples 11 and 16.) In this case, the noise floor may be displayed by disconnecting the RF from the laser and pushing **CLEAR WRT C**.

Display:

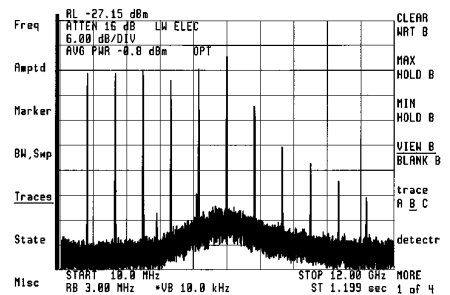

Agilent 71400C Measurement Example #11: Frequency Response with Tracking Generator

Measurement: Using a tracking generator, easily measure the frequency response of wide-bandwidth laser diodes in real time.

Setup:



Menu Selection Sequence: IP

State; track gen, SRC PWR On [-10 dBm] (or TG output power of interest), STIM RSP On (sets proper sweep rates)
 BW,Swp; VID BW [30 kHz]
 Freq; START [10 MHz]; STOP [15 GHz]
 Amptd; more, LW MODE Elec, more, SYS COR Off, more, REF LVL [-10 dBm or as needed], ATTEN [0 dB or minimum value so that the trace doesn't exceed the maximum mixer level]
 State; SAVE [1]

Connect the tracking generator output to the RF input..

State; select input, In 2 μ W 70810B
 Traces; CLR WRT B, STORE B

Connect the tracking generator output to the laser input

State; RECALL[1]
 Trace; VIEW B, CLR WRT C, more, more DSP LIN [-10 dBm], more, more, more, A-B+DL->A, On

Comments: Measure the modulation frequency response of a wide-band laser with tracking-generator modules. The Agilent 70300A RF tracking-generator module covers the 100-kHz to 2.9-GHz range; the Agilent 70301A microwave tracking-generator module covers the 2.7- to 18 GHz range. To completely cover the 100-kHz to 18-GHz range, you must include both modules. The two modules may be connected so that only one output cable is required to cover the full range. The analyzer will automatically select the proper module as the active source.

The figure shows two traces on the display. Trace A is the corrected frequency response of the laser, and Trace C is the noise floor trace before turning on the source power of the tracking generator.

This measurement turns off the system corrections so that errors in both the frequency response of the electrical spectrum analyzer and the tracking generator can be normalized out in the lightwave measurement of the laser's frequency response.

Display:

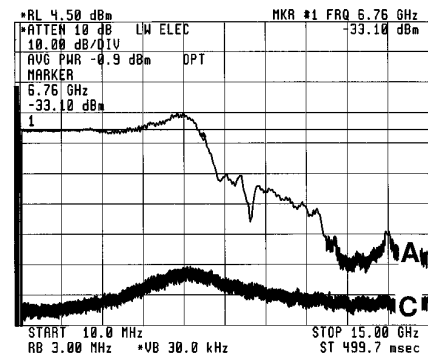

Important: When subtracting traces, similar dB units must be used. Therefore, only use **LW MODE Elec** in conjunction with microwave mode. Both modes are in electrical dB. Switching the lightwave signal analyzer back to the **LW input** (IN 1 LW 70810B) causes the display mode to return to **LW MODE Opt**. Be sure that you **RECALL** the state saved, [1] in this example, to ensure proper units are being used.

Agilent 71400C Measurement Example #12: Linewidth of DFB Laser Diode

Measurement: Measure linewidth of a distributed feedback (DFB) laser.

Setup:

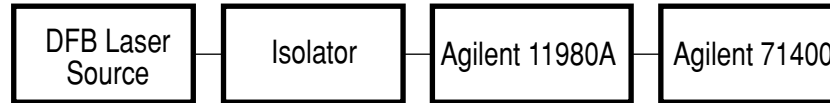

Menu Selection Sequence: IP

Freq; STOP [500 MHz], More, LIMIT START (will activate RBW), use the down arrow to adjust the RBW to 1 MHz
 BW, Swp; VID BW Man 1 kHz
 Amptd; REF LVL [-41 dBm], ATTEN [0 dB], more, LOG dB/DIV [3 dB], more LW MODE Elec, power meter, PWR BAR Off
 Marker; MKR NRM On, [0 Hz], more, more mkr bw/mkr zoom, REL RIGHT [-3 dB], REL LEFT [0 dB], MKR BW On
 Traces; STORE A, STORE B, STORE C, for trace comparisons

Comments: First, you must provide sufficient optical isolation to perform a successful measurement of a DFB laser. The optical isolation prevents reflected light from perturbing the lineshape of the laser during measurement. Typically, greater than 50-dB isolation is required. Next, you must rotate the polarization knob on the Agilent 11980A to maximize the displayed amplitude. Then, you can measure the linewidth, as shown here for three different laser current levels. Using the marker bandwidth procedure, place the marker 3-dB below the trace peak.

Although you might think that the measured linewidth is the half linewidth of the laser, it is actually the true linewidth. This occurs because the displayed spectrum is broadened by a factor of two relative to the actual spectrum, a result of the optical autocorrelation process involved. (See chapter 1.) Therefore, measuring the displayed half linewidth gives the numerical value for true linewidth, assuming that the lineshape is near-Lorentzian (a Lorentzian lineshape falls off at a 6 dB/octave rate above the linewidth frequency, as these examples do.)

Customarily, electrical dB has been used to measure linewidth. Therefore, use the lightwave electrical display units, **LW MODE Elec**, to measure the 3-dB linewidth of the DFB laser. Alternatively, use the lightwave optical display units, **LW MODE Opt**, and measure linewidth at the -1.5 dB point for the same linewidth measurement. The **marker bw** function is handy because the marker tracks variations in the signal. Notice that linewidth decreases with increased laser power.

Display:

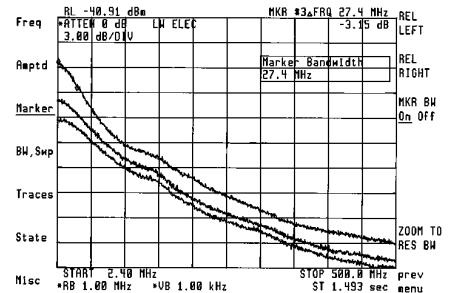

Note that, due to the insertion loss of the interferometer (about 8 dB), the amplitude scale is not calibrated in absolute-power terms for measurements made with the fiber-optic interferometer. Also note that, with limit start on, the reference marker is not at 0 Hz (2.4 MHz in this example). **LIMIT START** removes possible contributions to the measurement from the LO feedthrough at 0 Hz. When **LIMIT START** is pressed, the start frequency will activate resolution bandwidth.

When you change the resolution bandwidth, you will need to press **LIMIT START** again to obtain a start frequency value. For accurate linewidth measurements when using marker bandwidth or delta markers with **LIMIT START** on, you will need to add the start frequency (2.4 MHz in this example) to the markers answer ($27.4 + 2.4 = 29.8$ MHz in this example). Much of this error can be removed by selecting a lower resolution bandwidth if limit start is used.

Theory explains that the interferometer delay must be longer than the reciprocal of the linewidth to be measured for a small measurement error. Thus, to within a 10 percent overestimation due to field correlation, the Agilent 11980A, with 3.5 μ sec delay, can make linewidth measurements as low as 225 kHz. This encompasses most of the DFB lasers of today. Similarly, the Agilent 11980A Opt 005, with 25 μ sec delay, can measure linewidths as low as 30 kHz. Because of the 100 kHz low-frequency limit of the analyzer, a modulation sideband approach similar to the FM sideband measurement technique described in Chapter 1 and measurement example 14 is recommended to measure linewidths less than several hundred kilohertz.

Agilent 71400C Measurement Example #13: Chirp of a Modulated DFB Laser

Measurement: Measure spectral broadening (chirp) of a distributed feedback (DFB) laser under high-level modulation.

Setup:

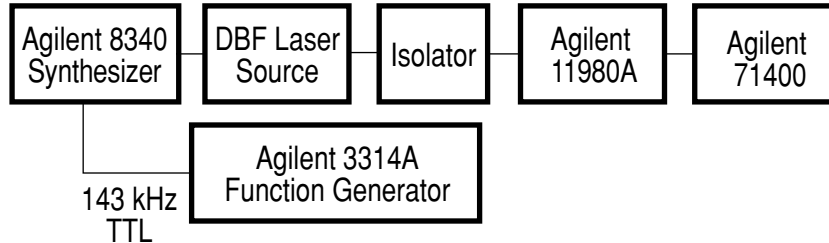

Menu Selection Sequence: IP

Amptd; more, LW MODE Elec, power meter, PWR BAR OFF, prev menu, more, more, REF LVL [-35 dBm], LOG dB/DIV [5 dB]
 BW, Swp; VID BW Man [10 kHz]
 Freq; STOP [6 GHz], more, LIMIT START
 Traces; STORE A, (unmodulated laser response), CLR WRITE B, STORE B, (modulated laser response) for comparison
 Marker; MKR NRM On [24 MHz], more, more, MKR TRA B, mkr bw/zoom bw, REL RIGHT
 Agilent 8340; CW mode, Freq = 100 MHz, Pulse mode On
 Agilent 3314; Square wave, 143 kHz $\pm 5\%$ (20 kHz for the Agilent 11980A Opt 005), 3Vp-p, 1.5v offset, (TTL) into the Agilent 8340 pulse input

Comments: To successfully measure the chirp of a DFB laser, you must provide sufficient optical isolation, which prevents reflected light from perturbing the lineshape of the laser. After connecting the laser to the interferometer, rotate the polarization knob on the Agilent 11980A to maximize the displayed amplitude. With the RF source off, the analyzer measures the linewidth of the laser. Turn on the signal generator to the RF frequency of interest (100 MHz here) and gate this RF modulation on and off (pulse modulate) with a 143-kHz ($\pm 5\%$) squarewave (20 kHz for the Agilent 11980A Opt 005). The laser linewidth has broadened to 4.0 GHz under modulation. This is called laser chirp or spectral broadening.

To determine the laser chirp, place the marker at the 3-dB point on the left edge of the pulse spectrum using the marker-bandwidth procedure outlined above or using normal-marker and delta-marker functions. The mixing process involved (see chapter 1) folds the two-sided spectrum around 0 Hz. Therefore, you only see the peak deviation on the analyzer for the case of symmetrical chirp. Thus, the full peak-to-peak deviation will be twice the displayed frequency deviation (8 GHz here). Since it is customary to use the 3-dB electrical level when measuring linewidth, lightwave electrical mode is shown here. Or you can use the lightwave optical mode; if you do so, measure the linewidth at the -1.5-dB point.
 Note: When using a fiber-optic interferometer, such as the Agilent 11980, the amplitude scale is not calibrated in absolute power terms.

Display:

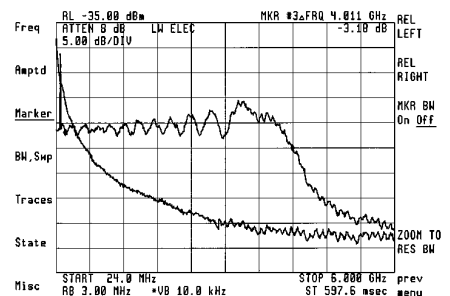

Agilent 71400C Measurement Example #14: FM Power Spectrum of a DFB Laser

Measurement: Measure power spectrum of a distributed feedback (DFB) laser under modulation.

Setup:

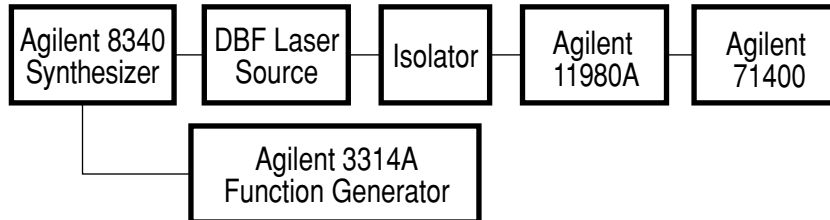

Menu Selection Sequence: IP

Amptd; more, LW MODE Elec, power meter, PWR BAR
OFF, prev menu, more, more, REF LVL [-35 dBm],
LOG dB/DIV [5 dB]
BW, Swp; VID BW [10 kHz]
Freq; STOP [10 GHz], more, LIMIT START
Agilent 8340; CW mode, Freq = 700 MHz, Pulse mode On
Agilent 3314; Square wave, 143 kHz \pm 5% (20 kHz for the
Agilent 11980A Opt 005), 3 Vp-p, 1.5 v offset (TTL)
into the Agilent 8340 pulse input

Comments: You must provide sufficient optical isolation to perform a successful modulation-spectrum measurement of a DFB laser. The optical isolation prevents reflected light from perturbing the lineshape of the laser during measurement. Rotate the polarization knob on the Agilent 11980A to maximize the displayed amplitude. Gate the RF modulation supplied to the laser on and off with a 143 kHz (20 kHz Opt 005), \pm 5% (ITL) square wave (See previous examples.)

The displayed spectrum consists of both intensity- and frequency-modulated components. In this case, the low-level FM components dominate the full-modulation spectrum. Because the first-order FM sideband is nulled in this example, you know from FM (Bessel) theory that the FM modulation index, beta, is approximately 3.8. The direct intensity-modulation feedthrough appears at the modulation frequency (700 MHz) as a narrow spike whose width equals the resolution bandwidth of the analyzer. Elsewhere, the FM spectral components of the modulated laser are resolved to a bandwidth approximately equal to twice the unmodulated linewidth of the laser, depending on modulation power level. (See chapter 1.) Thus, you can measure the linewidth of the laser under modulation. Using this measurement technique, the minimum measurable linewidth is limited only by the interferometer's delay time, since the FM spectral components appear far above the low-frequency limit of the analyzer.

Display:

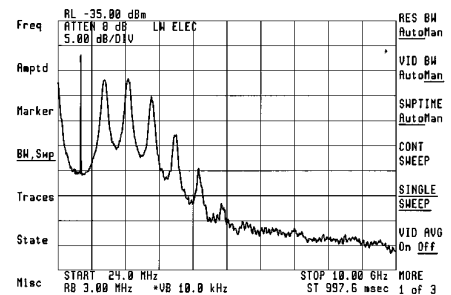

Agilent 71400C Measurement Example #15: Optical Heterodyne YAG Laser Spectrum

Measurement: Measure power spectrum of a YAG laser by using two identical lasers in an optical heterodyne arrangement.

Setup:

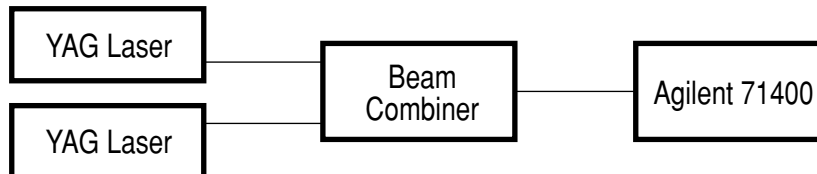

Menu Selection Sequence: IP

(plot #1)	(plot #2)
Freq; Center [freq of signal], SPAN [1 MHz]	Freq; Span [10 MHz]
Marker; HIGHEST PEAK, DELTA,NEXT PEAK, more, more, more, SIG TRK On	Marker; MKR NRM On, HIGHEST PEAK, more, more, mkr bw/zoom bw, MKR BW On
Bw, Swp; RES BW [1 kHz]	BW, Swp; CLR WRT A, MAX HOLD, TRACE B, CLR WRT B

Displays:

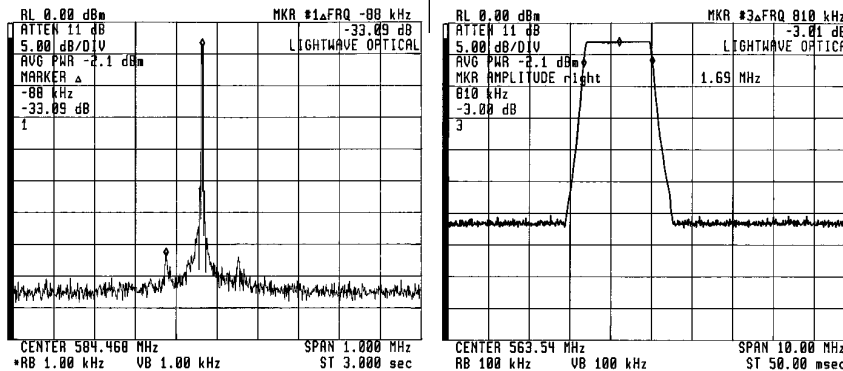

Comments: The linewidth of a YAG laser is comparable to the linewidth of an electronic oscillator, but the frequency stability is not. In the left-hand trace above, you see the linewidth of a YAG laser as observed in a 1-kHz resolution bandwidth. Generally, you cannot use a narrower span than shown because the frequency stability is too poor. The right-hand trace, for example, shows a 20-sec time interval during which the **PEAK HOLD** feature was used to trace out the extent of the frequency deviation undergone by the laser. Here, the limits were measured as 1.67 MHz using the marker bandwidth feature. In the left-band trace, you see some sidebands located 33-dB below the main signal, measured using marker delta. Optical heterodyning is the preferred method of measuring frequency spectra of narrow-linewidth lasers. This preference is due to the excellent dynamic range of optical heterodyning, its frequency stability, and its instantaneous linewidth.

This technique can also be applied to DFB lasers.

Agilent 71400C Measurement Example #16: Photoreceiver Frequency Response

Measurement: Using a tracking generator to modulate a laser diode, measure photodetector frequency response in real time.

Setup:

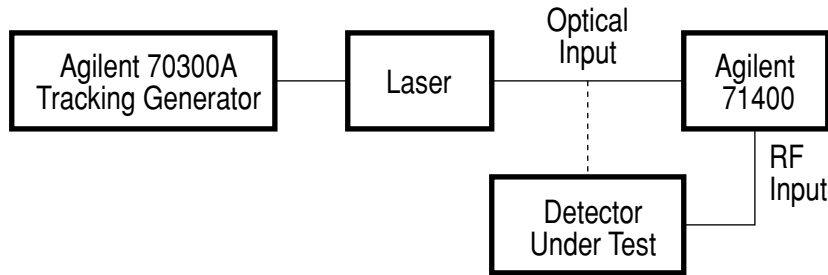

Menu Selection Sequence: IP

Amptd; more, LW MODE Elec (for measuring the laser output), more, more, REF LVL [-10 dBm], ATTEN [10 dB], more, SYSCOR Off
 State; track gen, SRC PWR ON [-10 dBm], STIM RSP ON;
 Traces; Select B, CLR WRT B, STORE B (Laser output), more, more, DSP LIN On (place on peak of trace B)
 State; select input, IN 2 μ W Agilent 70810B (switch to microwave mode),

Connect laser output to the photodetector input

Trace; Select C; CLR WRT C, STORE C (unnormalized detector output), Select A, CLR WRT A, more, A-B+DL->A (normalized detector output)

Comments: To measure the modulation frequency response of a detector, you first store a sweep of the modulated optical-test power (using **LW MODE Elec**) in trace B. This compensates for lack of flatness in the modulated power of the optical source. Next, place the display line (DSP LIN On) at the highest point on the stored trace. Then, switch to microwave mode and store the swept detected power from trace C and trace A. To correct for the fact that laser modulation is not flat, press **A-B+DL** On. This generates the corrected trace, referenced to the display line. (If moved, the display line will drag the normalized trace with it.) The active trace is now the normalized frequency response of the photodetector. Alternatively, A-B->A may be used. For this function, the normalized trace is referenced to 0 dBm. In this example, normalization is appropriate to remove the unflatness of the laser source that is present in the measurements.

Notice that the photodetector frequency response is higher in amplitude than the laser. This is due to the 300 volts/watt responsivity of the Agilent 11982A optical to electrical converter.

Display:

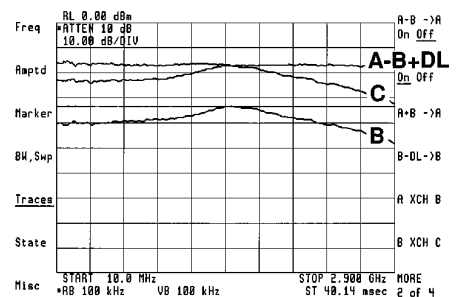

For more information about Agilent Technologies test and measurement products, applications, services, and for a current sales office listing, visit our web site,

www.agilent.com/comms/lightwave

You can also contact one of the following centers and ask for a test and measurement sales representative.

United States:

Agilent Technologies
Test and Measurement Call Center
P.O. Box 4026
Englewood, CO 80155-4026
(tel) 1 800 452 4844

Canada:

Agilent Technologies Canada Inc.
5150 Spectrum Way
Mississauga, Ontario
L4W 5G1
(tel) 1 877 894 4414

Europe:

Agilent Technologies
Test & Measurement
European Marketing Organization
P.O. Box 999
1180 AZ Amstelveen
The Netherlands
(tel) (31 20) 547 2000

Japan:

Agilent Technologies Japan Ltd.
Call Center
9-1, Takakura-Cho, Hachioji-Shi,
Tokyo 192-8510, Japan
(tel) (81) 426 56 7832
(fax) (81) 426 56 7840

Latin America:

Agilent Technologies
Latin American Region Headquarters
5200 Blue Lagoon Drive, Suite #950
Miami, Florida 33126, U.S.A.
(tel) (305) 267 4245
(fax) (305) 267 4286

Australia/New Zealand:

Agilent Technologies Australia Pty Ltd
347 Burwood Highway
Forest Hill, Victoria 3131, Australia
(tel) 1-800 629 485 (Australia)
(fax) (61 3) 9272 0749
(tel) 0 800 738 378 (New Zealand)
(fax) (64 4) 802 6881

Asia Pacific:

Agilent Technologies
24/F, Cityplaza One, 1111 King's Road,
Taikoo Shing, Hong Kong
(tel) (852) 3197 7777
(fax) (852) 2506 9284

Technical data subject to change
Copyright © 1989, 1992, 2000
Agilent Technologies
Printed in U.S.A. 7/00
5954-9137E